



IMAGINE A WORLD OF
SOFT WATER

What is hard water?

How naturally soft rainwater becomes hard and causes limescale in your home



Your water supply comes from rainwater, which is naturally soft when it falls.

As it flows underground it picks up calcium and magnesium minerals which make it hard.

This hard water eventually enters your home, and, when heated, produces limescale. It also reacts with soap to form a greyish scum.

Do you have hard water?

If you live in a hard water area, limescale can cause damage throughout your home

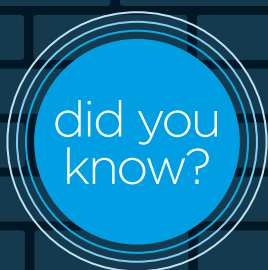
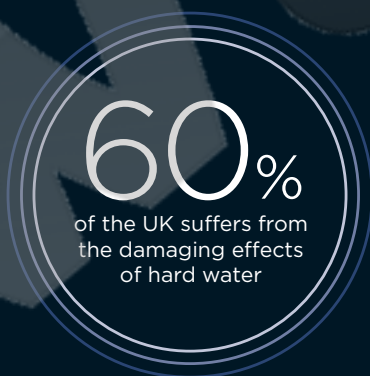
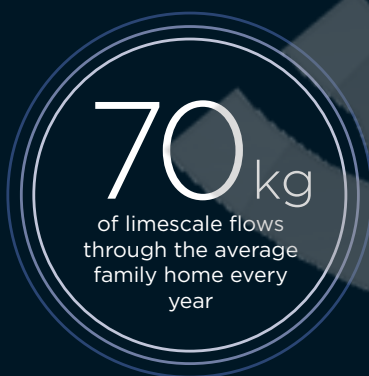

70 kg of limescale is the equivalent of 35 bricks rattling around your pipes!

Don't just take our word for it!

Ask your Authorised Kinetico Dealer for a hard water test strip or visit our website and simply type in your postcode to see if you have hard water.

Limescale damage in the home

Limescale can cause an untold amount of damage to your home. There's the damage you can see and the damage you can't. If you live in a hard water area, all of these problems will be familiar:



the damage
you **can** see



...and the damage you **can't**

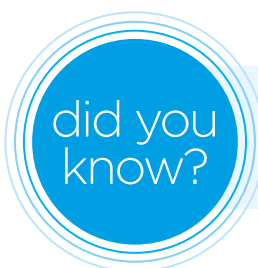

On average, it takes around 168 showers to clog your showerhead with limescale if you have hard water. If you shower twice a day, you'll notice the flow of water drop in less than three months. And if you have a new shower, it won't stay new for long!

The benefits of soft water around your home

Limescale is a battle that can't be won. It's a daily irritant that you may scrub away for now but it always returns. Imagine if you could always have beautifully soft water that, instead of fighting against you, will work with you to lovingly care for and protect your home...

Save hours cleaning

A home with soft water is a home without limescale. Just think of the time you'll save cleaning and how proud you'll be of your shiny home.



Protect and prolong the life of your appliances

All of your appliances that use water will stay scale-free and work more efficiently with soft water running through them.

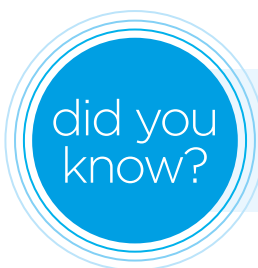

A university study demonstrated that soft water reduces the amount of household cleaning time by 10 working days per year. We think you'll agree your time could be better spent.

The benefits of soft water to you and your family

Soap and detergents do not work well with hard water. To make a good lather you need to use much more: not only can this be costly, you can also see and feel the effects. Soft water creates a rich, creamy lather using less soap or detergent, and it can be easily rinsed away...



Laundry that stays like new

If you've ever wondered why your towels and laundry feel hard and crusty you needn't look very far. The culprit is hard water.

If you have hard water, you need to use more detergent to clean effectively. Your washing machine cannot rinse it all out properly so it stays in your clothes making them hard and rough.

Soft water lathers beautifully and cares for your laundry too.

Water that's gentle on your skin and hair

Using double the amount of soap and shampoo to make it lather can have a detrimental effect on your skin and hair.

The soap residue that's left behind on your skin clogs the pores and can irritate the skin, making it itchy, flaky, and dry. You then spend more on creams and moisturisers to compensate.

Soft water will give you beautiful soft skin and hair.

Relief from eczema and dry skin

Many people with eczema and dry skin conditions have found their skin improves when they install a water softener.

Calcium and magnesium minerals which can potentially irritate the skin are removed, as is the need to use more soap and detergent — products known to potentially exacerbate eczema.

Soft water can help relieve those suffering with dry skin conditions.

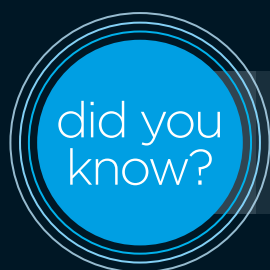

In a 3 month Talk Eczema Trial, 83% of trial participants said having soft water helped reduce the severity of their eczema.

The perfect solution - a Kinetico water softener



Non-electric smart valve

Our patented smart valve is powered by water meaning there's no increase in electricity bills and no fiddly meters to set.



Twin-tank technology

Only a twin-tank design will guarantee you a supply of soft water all day, every day.

Ion exchange

The most effective method of removing calcium and magnesium from hard water.

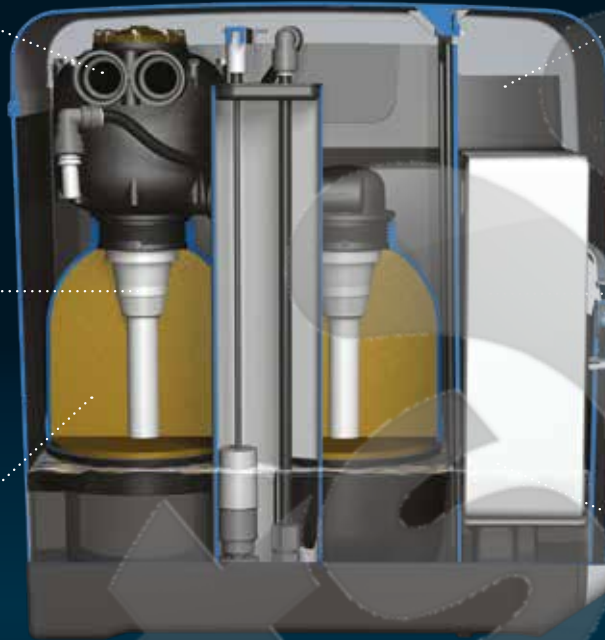

Designed for convenience

From the easy-lift magnetic lid to the salt viewing window, enjoy soft water without the hard work.



Easy to maintain

Kinetico block salt is convenient to store, handle and load and comes in easy to carry, robust plastic bags.



Compact design

One of the smallest water softeners on the market - the Premier Compact fits easily into the smallest of spaces.

Your questions answered

What maintenance does it require?

Adding salt to your machine is the only maintenance you'll have to do. You'll see the salt level gradually go down - when it's at a very low level, it's time to refill.

How much salt will I use?

It depends on how much water you use and how hard your water is, but on average we recommend one block per person, per month.

How much does salt cost?

We recommend that you use block salt which can be purchased from your Authorised Kinetico Dealer. They come in handy carry bags which are easy to handle and store. Typically, it will cost on average family of four £10 a month.

Is a water softener noisy?

Premier water softeners have 'QuietDrive' technology which means they operate at low noise levels.

Will there be a pressure drop in the flow of water?

There are many factors in your home that may cause a pressure drop. However, a Kinetico water softener has been specifically designed not to affect the flow.

How long will my softener last?

Every Kinetico water softener goes through rigorous quality control checks before it leaves the factory. And with an industry leading 10 year parts warranty, you are guaranteed years of trouble-free use. In fact, some of our softeners have been known to last for 35 years!

Will it clean off the limescale in my existing pipes?

This is not an instant process but over time soft water will remove the scale. A water softener should be an essential appliance for anyone moving into a new home to keep everything looking and running like new.

Why choose Kinetico?



the technology inventors

We invented the non-electric, twin-tank valve over 45 years' ago and still lead the world today.



world no.1 in water treatment

Our engineers develop smart solutions for the world's water problems.



quality & reliability guaranteed

We've always made only the most efficient and reliable water systems.



expert dealer network

Your local Kinetico dealer will always give the best, impartial advice.



non-electric technology

We use the kinetic energy of moving water to power our systems.

premier COMPACT

e-max technology

The **Kinetico Premier Compact** with e-max technology combines maximum performance and eco-efficiency in a compact design for the ultimate in soft water convenience.



Dimensions		
Size (w x d x h)	219 x 468 x 498 mm	
Performance	HE	HF
Minimum Flow	0.25 l/min	1 l/min
Maximum Peak Flow	41 l/min	51 l/min
Regeneration		
Time	11 minutes	11 minutes
Volume	20.5 litres	20.5 litres
System		
Max Operating Pressure	6 bar	6 bar

For households with 1-3 bathrooms

- Twin-tank technology for continuous soft water 24/7
- Block salt for easy loading
- QuietDrive - it won't disturb you, we promise



Registered products receive a **free 10 year warranty**



Our customers demand reliability, value and performance

We are proud to supply water softeners to millions of homes and companies around the world. From five-star hotels to world-renowned brands, every Kinetico customer – has discovered why the original is always the best.



Rolls-Royce

premier MAXI

emax
technology

The **Kinetico Premier Maxi** is a high performance, semi-commercial water softener for households with 3-6 bathrooms. It is a larger version of the Premier Compact, with all the same benefits, but a faster flow rate throughout.

Dimensions	
Size (w x d x h)	290 x 689 x 691 mm
Performance	
Minimum Flow	1 l/min
Maximum Peak Flow	57 l/min
Regeneration	
Time	11 minutes
Volume	34 litres
System	
Max Operating Pressure	8.3 bar



For households with 3-6 bathrooms

- Exceptional flow rates for a continuous supply of soft water
- Efficient salt usage
- QuietDrive – it won't disturb you, we promise



Registered products receive
a **free 10 year warranty**



The household appliance that pays for itself!

Not many appliances actually pay for themselves. A Kinetico water softener does. The savings that you'll make from owning a Kinetico water softener means you'll recoup your investment in a short period of time.

ITEM	COST	% SAVED PER USE
SHAMPOO	£5.90	75%
TOILETRIES	£13.28	75%
FABRIC DETERGENT	£9.69	50%
FABRIC CONDITIONER	£3.89	100%
WASHING-UP LIQUID	£0.78	50%
DISHWASHER POWDER	£2.20	75%
DISHWASHER SALT	£1.50	100%
LIMESCALE REMOVER	£4.40	100%
GENERAL CLEANERS	£4.72	50%

.....
TYPICAL MONTHLY SAVING
£33.43
.....

SOURCE - TESCO, JULY 2014. SAVINGS BASED ON AVERAGE FAMILY OF FOUR

Cut your household shopping bill

We estimate you could typically **save more than £33 a month** by reducing your shopping bill on detergents and toiletries, where you'll use significantly less or they're simply not needed.

Washing detergent manufacturers also recommend using **less detergent with soft water.**

Take a look on your pack the next time you buy one.



Avoid costly repairs and loss of energy efficiency

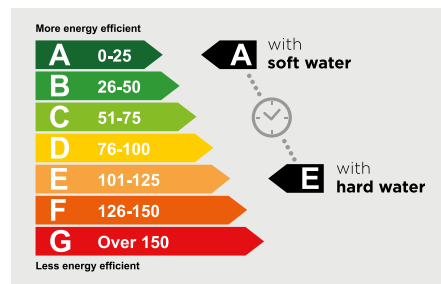
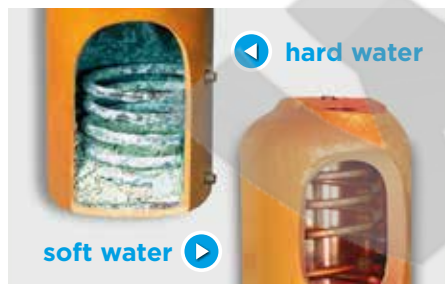

According to Government research 1.6mm scale can reduce energy efficiency by **15%**.

£530 is the typical cost to replace the heat exchanger on a gas boiler.

Maintain the original **efficiency rating** of your washing machine, kettle or hot water system.

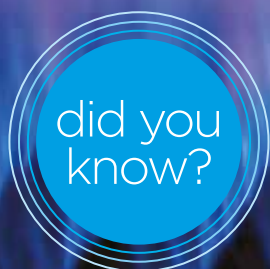

The average boiler repair is £235.37 with a new boiler costing between £1,800 - £3,500. That's a bit of a shock to most finances, so don't wait for it to happen — protect your appliances with soft water today.

What customers are saying

“Compact and low maintenance, these water softeners are well worth the investment. What’s not to like!”

Verity Mann,
Good Housekeeping Institute

“The installation was hassle-free and fitted easily into the cupboard under the sink. You can use much less detergent and cleaning products to get the same amount of foam and cleaning power.”

Trisha Schofield,
Good Housekeeping Institute

“I have had a Kinetico water softener for well over 20 years and I would not be without one.”

Kinetico
Customer

“The service engineer who installed our water softener was absolutely fabulous.”

Kinetico
Customer

“I would give our local Kinetico Dealer 11 out of 10.”

‘Independent Consumer Research conducted July 2017’

Contact your local authorised Kinetico dealer today!

Your Kinetico dealer will:

- Survey your household plumbing to ensure a water softener can be installed
- Explain the benefits of owning a water softener
- Use their years of expertise to recommend a water softener that is suitable for you, your home and your budget
- Answer any questions you may have
- Provide a written quotation
- Give you on-going after-care for complete peace of mind.

Kinetico UK Ltd

Bridge House | Park Gate Business Centre | Park Gate | Hampshire | SO31 1FQ

Call: 0800 056 8686 | **Email:** info@kinetico.co.uk | **Visit:** kinetico.co.uk

© Kinetico UK Ltd 2018. Kinetico reserves the right to amend details or specifications without notice.
All trademarks are registered to Kinetico Incorporated, Newbury, Ohio